

2003 BKO SCHEMATIC

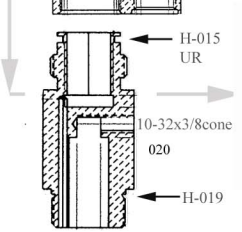

Low Pressure Regulator

- 202051 H-011 O-Ring
- 202076 Spring
- Brass Guide
- H-014 Oring 202054
- 10-32x3/8 set

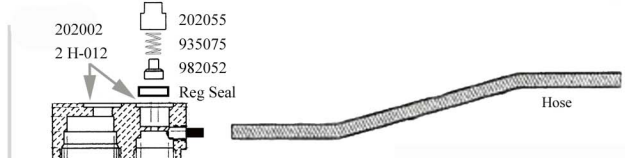
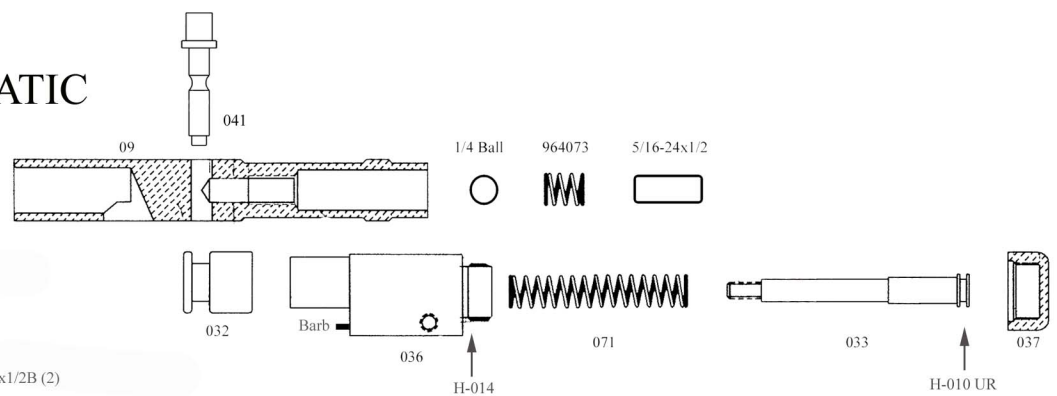
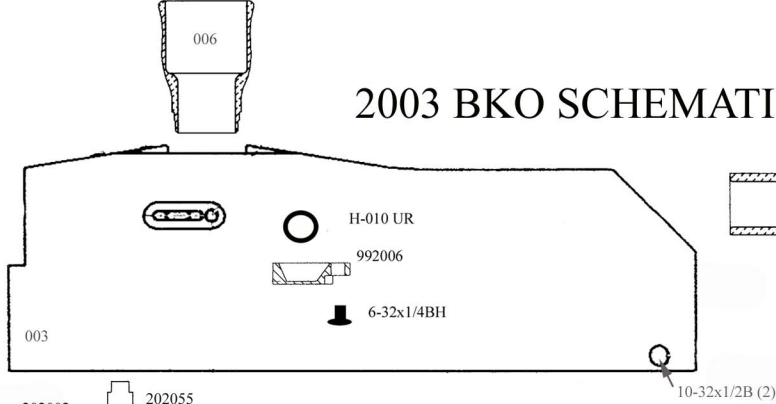
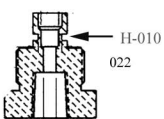
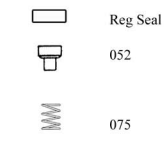
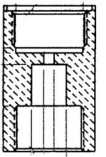
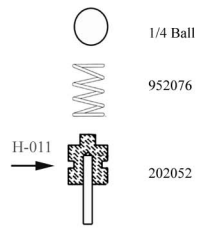
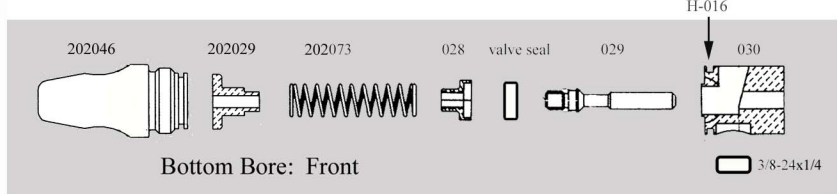

202001	Lower Receiver/Tray
202002	Regulator Mount
202003	Upper Receiver
982006	Feed Tube
982009	Bolt
202020	HP Reg Upper Body
202021	HP Reg Middle Body
202022	HP Reg Cup Housing
982028	Valve Cup
982029	Valve Pin
982030	Valve Seat
202030PK	3-way Solenoid Valve
982032	Hammer
202033	Cylinder Piston
202036	Cylinder Main Body
202037	Cylinder End Cap

982041	Link Pin
982052	Reg Cup
202052	HP Regulator Piston
202051	LP Reg Piston
202054	LP Reg Body
202055	LP Reg Cup Housing
202046	Volume Chamber
992006	Ball Detent Housing
993024	Trigger
993045	Grip Frame
202071	Cylinder Main Spring
202073	Valve Spring
935075	Reg Cup Spring
952076	Reg Main Spring
964073	Bolt Retention Spring
993074	Trigger Spring

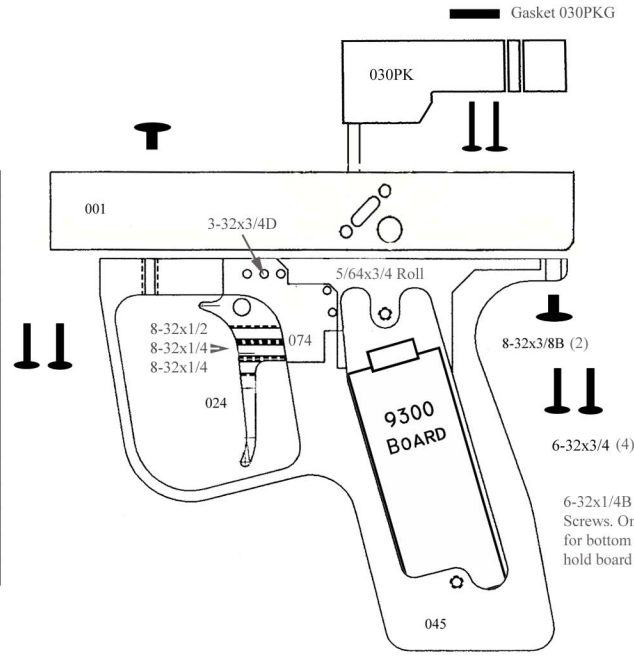

6-32x1/4B (3) Grip panel Screws. One 6-32x3/8B for bottom right corner to hold board in place.